



PROFIL ČESKÉ ZBROJOVKY a.s., UHERSKÝ BROD

(CZ) Česká zbrojovka a.s., založená roku 1936, byla původně zaměřena na výrobu ručních vojenských zbraní, avšak postupem času byla výroba rozšířena také o výrobky pro civilní použití, a to jak v oblasti sportovní, tak i lovecké. Společnost se proslavila výrobou samopalů vzor 58, který je dodnes ve výzbroji Armády ČR a SR. Neméně populární byl později i samopal vzor 61 Škorpion. Pistole CZ 75, která se od sedmdesátých let v různých modifikacích dodnes vyrábí, se stala jednou z nejoblíbenějších a nejkopírovanějších zbraní na světě. Mezi světovou špičku se dnes řadí pistole CZ 75 D Compact ráže 9 mm Luger, která se úspěšně účastní ve výběrových řízeních ozbrojených složek v řadě zemí. Touto zbraní je přezbrojována Policie ČR, které bude na základě kontraktu dodáno 46 000 kusů.

PROFILE OF ČESKÁ ZBROJOVKA a.s., UHERSKÝ BROD

(GB) Česká Zbrojovka a. s. (Czech Arms Factory, joint-stock company), founded in 1936, was originally oriented for military small arms production, but over the time the product range was expanded with products for the civilian use, in both the spheres of sports and hunting. The company became famous for its production of the Model 58 Assault Rifle, which still remains part of the armament of the Czech Armed Forces and of Slovak Republic. The Model 61 Skorpion submachine gun was certainly no less popular. The CZ 75 pistol, which is being manufactured in various versions and modifications since the seventies up to these days, has become one of the most popular and copied pistol in the world. The CZ 75 D Compact cal. 9 mm Luger pistol is today rated as the top class of its kind in the World winning armed forces tenders in many countries. This is the very pistol designed for re-arming of the Czech Republic Police and as based upon the contract in the following four years 46 000 units will be supplied to the Police and Law Enforcement Agencies in the Czech Republic.

PROFIL DES UNTERNEHMENS ČESKÁ ZBROJOVKA a.s., UHERSKÝ BROD

(D) Česká zbrojovka a.s., gegründet im Jahre 1936, war ursprünglich auf die Produktion von Militärhandwaffen gerichtet. Mit der Zeit wurde die Produktion jedoch auch um Produkte für Zivilverwendung erweitert, und sowohl im Sport-, wie auch im Jagdbereich. Die Gesellschaft wurde durch die Produktion des Sturmgewehres Mod. 58 berühmt, der bis zur heutigen Zeit zu der Ausrüstung der tschechischen und slowakischen Armee gehört. Nicht weniger populär war später auch die Maschinenpistole Mod. 61 Skorpion. Die Pistole CZ 75, die seit der siebziger Jahren in verschiedenen Modifikationen bis heute produziert ist, wurde zu einer der beliebtesten und meist kopierten Waffen in der Welt. Zu der Weltspitze gehört heute die Pistole CZ 75 D Compact Kaliber 9 mm Luger, die erfolgreich an den Ausschreibungen der bewaffneten Einheiten in der Reihe von Ländern teilnimmt. Mit dieser Waffe wird die Polizei der Tschechischen Republik umgerüstet. Aufgrund des signierten Kontraktes wird die Polizei 46000 Stück der Pistolen bekommen.

PROFIL DE ČESKÁ ZBROJOVKA a.s., UHERSKÝ BROD

(F) Česká zbrojovka a.s., établi en 1936, de son origine a été orientée à la fabrication des armes militaires légères, néanmoins au cours du temps la production a été agrandie également avec des produits pour l'usage civil, pour les buts sportifs et de chasse. La société a reçu une célébrité par ses mitrailletes Modèle 58, qui sont concernés dans l'armement de l'armée tchèque et slovaque encore. Le pistolet automatique Modèle 61 Skorpion est devenu populaire plus tard. Le pistolet Modèle CZ 75, fabriqué dans diverses modifications depuis 1975, est devenu une des armes les plus populaires et les plus copiés au monde. Modèle CZ 75 D Compact en calibre 9 m Luger, rangé au sommet de pistolets mondial à présent, participe avec succès aux marches publics pour les corps armées dans beaucoup de pays. Ces armes seront introduits pour les unités de police tchèques, selon le contrat ils seront fournis 46 000 pièces.

PERFIL DE LA COMPAÑÍA ČESKÁ ZBROJOVKA a.s., UHERSKÝ BROD

(E) La compañía Česká zbrojovka a.s., fundada en el año 1936, que originalmente fabricaba armas de puño militares amplió con el tiempo la producción incluyendo también productos de uso civil, incorporando la fabricación de armas deportivas y armas de caza. La compañía se hizo famosa con la fabricación de la ametralladora tipo VZ 58, que hasta el día de hoy forma parte del armamento de los Ejércitos Checo y Eslovaco. La misma fama adquirió más tarde también la ametralladora VZ 61 Skorpion. La pistola CZ 75, producida desde los años setenta en varias modificaciones hasta ahora, se convirtió en una de las armas más solicitadas y más copiadas en el mundo. Entre las pistolas más destacadas en el mundo pertenece la pistola CZ 75 D Compact calibre 9 mm Luger, que participa con éxito en las licitaciones de las fuerzas armadas de muchos países. Este arma formará parte del equipamiento de la Policía Checa, que firmó un contrato para la entrega de 46 000 unidades.





PISTOLE / PISTOLS / PISTOLEN / PISTOLETS / PISTOLAS

2–15

subcompact

4–5

CZ 2075 RAMI
CZ 2075 RAMI P

compact

6–9

CZ 83
CZ 75 COMPACT
CZ 75 D COMPACT
CZ 75 D COMPACT P–01
CZ 85 D COMPACT
CZ 100
CZ 110

standard

10–15

CZ 75 B
CZ 75 BD POLICE
CZ 85 B
CZ 75 SP–01
CZ 75 SP–01 TACTICAL
CZ 75 FULL AUTO
CZ 97 B

PUŠKY / RIFLES / BÜCHSEN / CARABINES / FUSILES

16–17

CZ 452–2E ZKM Scout
CZ 527 Carbine
CZ 750 S1 M1

ÚTOČNÁ PUŠKA / ASSAULT RIFLE / STURMGEWehr / CARABINE D'ATTAQUE / FUSIL DE FRANCOtirADOR

18–19

Sa vz. 58
CZ 858 TACTICAL

DOPLŇKY / ACCESSORIES / ZUBEHÖR / ACCESSORIES / ACCESORIOS

20–25



handguns

handguns

subcompact







CZ 2075 RAMI

compact



CZ 75 D COMPACT

				
(CZ)	Rám*	Ráže	Délka hlavně (mm)	Rozměry zbraně (mm) Délka x Výška x Šířka
(GB)	Frame*	Calibre	Barrel length (mm)	Dimensions (mm) Length x Height x Width
(D)	Griffstück*	Kaliber	Lauflänge (mm)	Waffenmaße (mm) Länge x Höhe x Breite
(F)	Carcasse*	Calibre	Longueur du canon (mm)	Dimensions de l'arme (mm) Longueur x Hauteur x Largeur
(E)	Armazón*	Calibre	Largo del cañón (mm)	Dimensiones del arma (mm) Largo x Alto x Ancho
subcompact				
CZ 2075 RAMI	AL	9 mm Luger .40 S&W	76	167 x 120 x 32
CZ 2075 RAMI P	POLY	9 x 19 .40 S&W 9 mm P.A. Rubber	77	168 x 120 x 33
compact				
CZ 83	ST	7.65 mm Browning 9 mm Browning 9 mm Makarov 9mm P.A. Rubber	97	172 x 127 x 36
CZ 75 COMPACT	ST	9 mm Luger 9 x 21	98.5	184 x 128 x 35
CZ 75 D COMPACT	AL	9 mm Luger	98.5	184 x 128 x 35
CZ 75 B COMPACT	ST	.40 S&W	100	186 x 128 x 35
CZ 75 D COMPACT P-01	AL	9 mm Luger	98.5	184 x 128 x 35
CZ 85 D COMPACT	AL	9 mm Luger	98.5	184 x 128 x 35
CZ 100	POLY	9 mm Luger 9 x 21 .40 S&W	98	177 x 130 x 31
CZ 110	POLY	9 mm Luger 9 x 21	98	180 x 130 x 31
standard				
CZ 75 B	ST	9 mm Luger 9 x 21 .40 S&W	120	206 x 138 x 35
CZ 75 BD POLICE	ST	9 mm Luger 9 x 21 .40 S&W	120	206 x 138 x 35
CZ 85 B	ST	9 mm Luger 9 x 21 .40 S&W	120	206 x 138 x 38
CZ 75 SP-01	ST	9 x 19	120	207 x 147 x 37
CZ 75 SP-01 TACTICAL	ST	9 x 19	120	207 x 147 x 37
CZ 75 FULLAUTO	ST	9 mm Luger	152	206 x 138 x 35
CZ 97 B	ST	.45 Auto	123	212 x 150 x 35

* AL – Lehká slitina, Light alloy, Leichtmetalllegierung, Alliage léger, Aleación ligera / ST – Ocel, Steel, Stahl, Acier, Acero / POLY – Polymer, Polymer, Polymer, Polymère, Polímero







standard



CZ 75 B



CZ 75 FULL AUTO

				
Hmotnost s prázdným zásobníkem (g)	Kapacita zásobníku	Funkce spoušťového mechanismu	Manuální pojistka	Vypouštění kohoutu
Weight with empty magazine (g)	Magazine capacity	Trigger mechanism operation	Manual safety	Decocking
Gewicht mit leerem Magazin (g)	Magazinkapazität	Funktion des Abzugsmechanismus	Sicherung	Etspannhebel
Poids avec chargeur vide (g)	Capacité du chargeur	Mécanisme de détente	Sûreté - manuel	Désarmement
Peso con el cargador vacío (g)	Capacidad del cargador	Función del mecanismo de disparo	Seguro manual	Decocking
695	10 8	SA/DA	•	
665	10 / 14 8 / 10	SA/DA	•	
670	13	SA/DA	•	
750	15	SA/DA	•	
800	12			
800	12			
750	12			
920	14 / 16 14 / 16	SA/DA	•	
800	14 / 16	SA/DA		•
920	10	SA/DA	•	
800	14 / 16	SA/DA		•
800	14 / 16	SA/DA		•
665	13 13 10	DAO		
665	13 13	SA/DA		•
1 000	16 16 10	SA/DA	•	
1 000	16 16 10	SA/DA		•
1 000	16 16 10	SA/DA	•	
1 180	18	SA/DA	•	
1 180	18	SA/DA		•
1 000	16		•	
1 150	10	SA/DA	•	

subcompact subcompact



CZ 2075 RAMI

- (CZ) Záložní a obranná pistole pro služební i civilní skryté nošení.
- (GB) This pistol model is designed as back-up and personal defence handgun for concealed carry in duty or civilian use.
- (D) Reserve- und Verteidigungspistole für verdecktes Dienst- und Ziviltragen.
- (F) Pistolet réservé de la défense à porter caché pour des buts de service ou civil.
- (E) Pistola de reserva y de defensa personal para el porte oculto de servicio y civil.
- (CZ) Pistole nominována prestižním americkým časopisem Guns&Ammo na zbraň roku 2004 v USA.
- (GB) The pistol has been nominee in the USA by the prestigious American magazine Guns&Ammo for Gun of the Year 2004 Award.
- (D) Die Pistole ist von der amerikanischen Prestigezeitschrift Guns&Ammo als Waffe des Jahres 2004 in den USA nominiert worden.
- (F) Le pistolet a obtenu une nomination du journal américain de prestige Guns&Ammo comme arme de l'année 2004 aux Etats-Unis.
- (E) Pistola nombrada como arma del año en el 2004 en los EE.UU. por la revista americana de prestigio Guns&Ammo.



AL



9 mm Luger
.40 S&W



76



167 x 120 x 32



695



10
8



SA/DA



•





CZ 2075 RAMI P

- (CZ) CZ 2075 RAMI s plastovým rámem
- (GB) CZ 2075 RAMI with a plastic frame
- (D) CZ 2075 RAMI mit dem Kunststoffrahmen.
- (F) CZ 2075 RAMI avec la carcasse en matériau synthétique
- (E) CZ 2075 RAMI con el armazón de polímero



- 1 Závěr
Slide
Verschluss
Culasse
Cerradura
- 2 Hlaveň
Barrel
Lauf
Canon
Cañón
- 3 Předšurná pružina s vedením
Recoil Spring with Guide
Vorholfeder mit Führung
Ressort récupérateur
avec le tige guide
Resorte recuperador con guía
- 4 Rám
Frame
Griffstück
Carcasse
Armazón
- 5 Zásobník
Magazine
Magazin
Chargeur
Almacén



POLY	9 x 19 .40 S&W 9 mm P.A. Rubber	77	168 x 120 x 33	665	10 / 14 8 / 10 13	SA/DA	•	•
		77	168 x 128 x 33	670		SA/DA	•	•

compact compact

CZ 83 CZ 83 9 mm P.A. Rubber

- (CZ) Klasická zbraň pro ozbrojené složky, doplněná o nesmrtící gumové náboje 9 mm P.A. Rubber.
- (GB) Classic weapon for Law Enforcement and Armed Forces converted to less-lethal 9 mm P.A. Rubber cartridges.
- (D) Klassische Waffe für bewaffneten Einheiten. Ist um nichttödliche Gummipatrone 9mm P.A.Rubber ergänzt.
- (F) Une arme classique pour les corps armés, complétée de cartouche en caoutchouc non létale, calibre 9 mm P. A. Rubber.
- (E) Arma clásica para las fuerzas armadas. Completada con balas de goma 9 mm P.A.



ST	7.65 mm Browning 9 mm Browning 9 mm Makarov 9mm P.A. Rubber	97	172 x 127 x 36	750 800 800 750	15 12 12 12	SA/DA	•	

CZ 75 COMPACT

- (CZ) Spolehlivá a snadno ovladatelná pistole, kterou volí profesionálové k ochraně života, majetku a zákona.
- (GB) Reliable and easily manageable pistol chosen by professionals for defence of life, property and law enforcement.
- (D) Zuverlässige und leicht betätigende Pistole, die Profis zum Schutz des Lebens, Vermögens und des Gesetzes wählen.
- (F) Un pistolet fiable et facilement manié, choisi par les professionnels pour la défense de la vie, de la propriété et de la loi.
- (E) Un arma confiable y del manejo fácil, elegida por los profesionales para la protección de la vida, la propiedad y la ley.



ST	9 mm Luger 9 x 21	98.5	184 x 128 x 35	920	14 / 16 14 / 16	SA/DA	•	



CZ 75 D COMPACT P-01

- (CZ)** Vyhovuje podmínkám a situacím vyžadovaných moderní ochranou zákona. Hmotnost a rozměry ji předurčují pro osobní ochranu a dlouhodobé nošení.
Pistole nominována prestižním americkým časopisem Guns&Ammo na zbraň roku 2003 v USA.
- (GB)** Meets conditions and circumstances required by present-day law enforcement standards. Reduced dimensions and weight predispose this model for personal defence and long term carry.
This pistol model has been selected by prestigious American magazine Guns&Ammo as Gun of the Year - 2003 Nominee.
- (D)** Sie entspricht den Bedingungen und Situationen, die der moderne Gesetzschutz erfordert. Das Gewicht und Maße bestimmen sie im voraus zum Personenschutz und langzeitigem Tragen.
Die Pistole wurde von der amerikanischen Prestige-Zeitschrift Guns&Ammo zur Waffe des Jahres 2003 in den USA nominiert.
- (F)** Ces pistolets sont conformes aux conditions et situations de la défense moderne de la loi. Le poids et dimensions sont conçu pour la défense personnelle et à porter longtemps.
Ce pistolet a été proposé par le magazine américain prestigieux Guns&Ammo comme l'arme de l'année 2003.









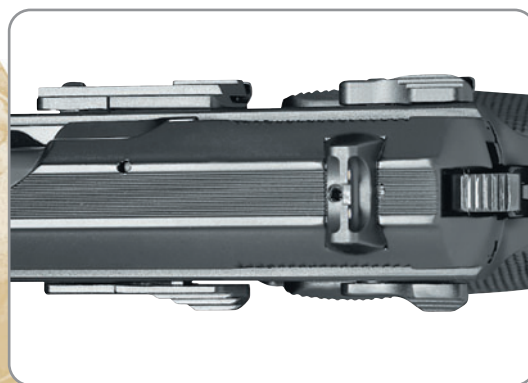

- (E)** Llena las condiciones y responde a las situaciones requeridas por la defensa moderna de la ley. El peso y las dimensiones la predestinan para la defensa personal y para un porte prolongado.
Esta pistola ha sido nominada como el Arma del año 2003 en USA por la prestigiosa revista norteamericana Guns&Ammo.

CZ 85 D COMPACT

- (CZ)** Modifikace pistole CZ 75 D Compact doplněná o oboustranné ovládání vypouštění kohoutu a záchytu závěru.
- (GB)** This pistol is the CZ 75 D Compact modification complemented with ambidextrous controls of decocking lever and slide stop.
- (D)** Modifikation der Pistole CZ 75 D Compact, ergänzt um beidseitige Entspann- und Verschlussfanghebel.
- (F)** Une modification du pistolet CZ 75 D Compact complété par le désarmement du chien et arrêtoir de culasse ambidextre.
- (E)** Una modificación de la pistola CZ 75 D Compact con el manejo ambidextro del martillo y del retén de la corredera.



									
CZ 75 D COMPACT P-01	AL	9 mm Luger	98.5	184 x 128 x 35	800	14 / 16	SA/DA		•
CZ 75 D COMPACT	AL	9 mm Luger	98.5	184 x 128 x 35	800	14 / 16	SA/DA		•
CZ 75 B COMPACT	ST	.40S&W	100	186 x 128 x 35	920	10	SA/DA	•	
CZ 85 D COMPACT	AL	9 mm Luger	98.5	184 x 128 x 35	800	14 / 16	SA/DA		•

compact compact



KADET

- (CZ) Nezbytné příslušenství vyvinuté k pistolím řady CZ 75/85 určené pro ekonomickou tréninkovou střelbu s nábojem v ráži .22 LR
- (GB) Necessary accessory developed for the CZ 75/85 pistol series designed for economic and practice shooting using .22 LR cartridges.
- (D) Erforderliches Zubehör, entwickelt für Pistolen der Reihe CZ 75/85, ist für wirtschaftliches Übungsschießen mit Patrone im Kaliber .22 LR bestimmt.
- (F) Kit de conversion, conçu pour les pistolets du série CZ 75/85, destiné pour le tir d'entraînement économique avec les cartouches en calibre .22 LR.
- (E) Un accesorio indispensable desarrollado para las pistolas de la serie CZ 75/85 destinado para el tiro de entrenamiento económico con un cartucho calibre .22 LR



SIMMUNITION

- (CZ) Doplněk pro pistole CZ 75/85 D Compact určený k takticko-technické přípravě elitních jednotek při nácvičce střelby muž proti muži v uzavřených prostorech.
- (GB) Accessory designed for the CZ 75/85 D Compact pistols intended for elite units close quarter combat training conducted at indoors environment.
- (D) Zubehör für Pistolen CZ 75/85 D Compact, das für taktisch-technische Ausbildung der Elitetruppen bei Schießübungen Mann gegen Mann in geschlossenen Räumen bestimmt ist.
- (F) Un complément du pistolet CZ 75 D Compact destiné pour la formation tactique de troupes d'élite et le entraînement du tir de l'homme contre l'homme dans l'espace fermé.
- (E) Un complemento de las pistolas CZ 75/85 D Compact destinado para la preparación táctica – técnica de las unidades de élite durante el entrenamiento del tiro cuerpo a cuerpo en espacios cerrados.

CZ 75 D COMPACT



Ukázky z některých technických zkoušek CZ 75 D Compact / Exhibits of some of technical tests conducted with the CZ 75 D Compact / Ausschnitte aus manchen technischen Prüfungen der Pistole CZ 75 D Compact / Démonstrations de quelques essais techniques avec CZ 75 D Compac / Muestras de algunas pruebas técnicas de la pistola CZ 75 D Compact.



KADET
SIMMUNITION

.22 LR
9 mm FX & CQT

124
104

187 x 41 x 24
165 x 41 x 25

475
382

10
14



CZ 100

- (CZ) Nízká hmotnost, výborná ergonomie a optimální bezpečnost předurčují tuto zbraň k celodennímu nošení. Vhodná pro osobní obranu a městské policejní složky.
- (GB) Low weight, excellent ergonomics and optimised safety features predispose this handgun to day-to-day carry.
- (D) Niedriges Gewicht, ausgezeichnete Ergonomie und optimale Sicherheit bestimmen die Waffe im voraus für ganztägiges Tragen. Geeignet für Personenschutz und Stadtpolizeinheiten.
- (F) Le poids bas, ergonomie excellente et haute sécurité prédestinent ce pistolet à porter pour toute la journée. Une arme appropriée pour la défense personnelle et des policiers municipaux.
- (E) Peso bajo, excelente ergonomía y una óptima seguridad predestinan este arma para el porte durante todo el día. Es recomendable para la defensa personal y para los cuerpos de policía municipales.



POLY	9 mm Luger 9 x 21 .40 S&W	98	177 x 130 x 31	665	13 13 10	DAO		

CZ 110

- (CZ) Inovace pistole CZ 100 umožňující ovládání spoušťového mechanismu v režimu SA/DA.
- (GB) The CZ 100 pistol innovation allowing shooting either in SA or DA modes of fire.
- (D) Innovation der Pistole CZ 100, die Betätigung des Abzugsmechanismus im SA/DA-Betrieb ermöglicht.
- (F) Innovation du pistolet CZ 100 permettant le maniement du mécanisme de détente au mode SA/DA.
- (E) La innovación de la pistola CZ 100 que facilita el manejo del mecanismo de disparo en el régimen SA/DA.



POLY	9 mm Luger 9 x 21	98	180 x 130 x 31	665	13 13	SA/DA		•

standard standard



CZ 75 B

- (CZ) Tradiční zbraň zavedená v ozbrojených složkách v mnoha zemích světa.
- (GB) Traditional handgun established in Armed Forces and Law Enforcement Units in many countries world over.
- (D) Traditionelle Waffe, eingeführt in bewaffneten Truppen in vielen Ländern der Welt.
- (F) L'arme traditionnelle, introduite par les corps armées dans beaucoup de pays du monde.
- (E) Un arma tradicional con el uso acreditado por fuerzas armadas y la policía en muchos países del mundo.











ST	9 mm Luger 9 x 21 .40 S&W	120	206 x 138 x 35	1 000	16 16 10	SA/DA	•	



CZ 75 BD POLICE

- (CZ) Policejní verze pistole CZ 75 doplněná o další bezpečnostní a ovládací prvky.
- (GB) Police version of the CZ 75 pistol completed with additional safety and controlling elements.
- (D) Polizeiversion der Pistole CZ 75, ergänzt um weitere Sicherheits- und Betätigungselemente.
- (F) Une version du pistolet CZ 75 pour policiers accompli d'autres dispositifs de sécurité et maniement.
- (E) La versión policial de la pistola CZ 75 complementada con elementos de seguridad y manejo adicionales.









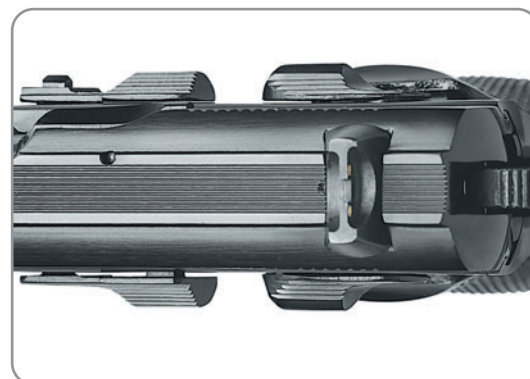

								
ST	9 mm Luger 9 x 21 .40 S&W	120	206 x 138 x 35	1 000	16 16 10	SA/DA		•

CZ 85 B

- (CZ) Vychází z oblíbené řady CZ 75. Nabízí oboustranné ovládání pojistky a záchytu závěru.
- (GB) The design of the CZ 85B stems from the popular CZ 75 line. This model offers ambidextrous control of the manual safety and slide stop.
- (D) Sie geht von der beliebten Reihe CZ 75 aus. Sie bietet beidseitige Bedienung der Sicherung und Verschlussfanghebels.
- (F) Pistolet dérivé de série populaire CZ 75, avec la sûreté et arrêtoir de culasse ambidextre.
- (E) Sale de la línea popular CZ 75. Ofrece el manejo ambidextro del seguro y del retén de la cerradura.



								
ST	9 mm Luger 9 x 21 .40 S&W	120	206 x 138 x 38	1 000	16 16 10	SA/DA		•

standard standard



CZ 75 SP-01

- CZ** Nejnovější pistole konstrukčně vycházející z CZ 75. Špičková zbraň určená pro všechny, kteří vyžadují maximální spolehlivost, bezpečnost a přesnost při rychlé střelbě.
- GB** The most modern pistol, whose design is based on CZ 75. The top weapon designed for all users who require maximum reliability, safety and accuracy of quick fire.
- D** Die neueste Pistole, in der Konstruktion von CZ 75 ausgehend. Eine Spitzenwaffe für alle, die Höchstsmaß an Zuverlässigkeit, Sicherheit und Genauigkeit beim schnellen Schießen erwarten.
- F** Le plus nouveau pistolet de la construction dérivée de CZ 75. L'arme de qualité suprême destinée pour tous, qui est-ce qu'ont besoin de la fiabilité maximale, sécurité et la précision en tir rapide.
- E** La pistola más novedosa, con el diseño que sale de la CZ 75. El arma de punta destinada para todos aquellos que exigen la máxima confiabilidad, seguridad y precisión durante el tiro rápido.



ST



9 x 19



120



207 x 147 x 37



1 180



18



SA/DA



•





CZ 75 SP-01 TACTICAL

- ⒸZ Nejnovější pistole konstrukčně vycházející z CZ 75. Zbraň určená pro profesionály - spolehlivá v extrémních podmínkách, bezpečná, výborně vyvážená a přesná při rychlé střelbě.
- ⒸGB The most modern pistol, whose design is based on CZ 75. The weapon is designed for professionals – it is reliable in extreme conditions, safe, excellently balanced and accurate in quick fire.
- ⒸD Die neueste Pistole, in der Konstruktion von CZ 75 ausgehend. Für Profis bestimmt – zuverlässig in extremen Bedingungen, sicher, perfekt ausgewuchtet und genau beim schnellen Schießen.
- ⒸF Le plus nouveau pistolet de la construction dérivée de CZ 75. L'arme destinée pour les professionnels, fiable dans les conditions extrêmes, sûre, très bien balancée et précise en tir rapide.
- ⒸE La pistola más novedosa, con el diseño que sale de la CZ 75. El arma destinada para profesionales – confiable en condiciones extremas, segura, con un balance perfecto y precisa durante el tiro rápido.



- ⒸZ Zbraň je opatřena drážkami určenými pro uchycení taktického příslušenství
- ⒸGB The weapon is furnished with grooves designed for attachment of tactical accessories.
- ⒸD Die Waffe ist mit Nuten zur Aufnahme des taktischen Zubehörs versehen.
- ⒸF L'arme est munie avec les rainures pour la fixation d'accessoires tactiques
- ⒸE El arma provista de rieles que sirven para sujetar los accesorios tácticos



ST



9 x 19



120



207 x 147 x 37



1 180



18



SA/DA



.

standard standard

CZ 75 FULL AUTO

- (CZ) Automatická pistole pro vysoce specializované policejní a vojenské jednotky. Umožňuje režim palby SA/DA a full-auto.
- (GB) Fully automatic pistol for highly specialised police and military units. Allows to conduct fire in SA/DA or full-auto mode.
- (D) Selbstladepistole für hoch spezialisierte Polizei- und Militäreinheiten. Sie ermöglicht Schießen im SA/DA- sowie Full-Auto-Betrieb.
- (F) Pistolet automatique pour les unités spécialisées de la police et de l'armée. Il permet le tir au mode SA/DA ou en rafale libre.
- (E) Pistola automática para las unidades de ejército y de policía altamente especializadas. Facilita el régimen del disparo SA/DA y full-auto.



ST



9 mm Luger



152



206 x 138 x 35



1 000



16



.





CZ 97 B

- (CZ) Časopisem Soldier&Fortune z USA vyhodnocena v roce 1999 jako nejpřesnější sériově vyráběná „Combat“ pistole v ráži .45 ACP.
- (GB) The Soldier of Fortune magazine issued in 1999, published in the USA, awarded this pistol with title of the most accurate serially produced "Combat" pistol in cal. .45 ACP.
- (D) Diese Pistole wurde in der USA-Zeitung Soldier&Fortune im Jahre 1999 als die präziseste serienmäßig produzierte „Combat“ Pistole mit Kaliber .45 ACP bewertet.
- (F) Un pistolet qui a été proposé par le magazine Soldier&Fortune comme la plus précise "Combat" pistolet en calibre .45 ACP de fabrication sérielle en 1999.
- (E) Pistola calificada por la revista Soldier&Fortune de USA en el año 1999 como la pistola más precisa entre las pistolas „Combat“ en el calibre .45 ACP producidas en serie.



ST



.45 Auto



123



212 x 150 x 35



1 150



10



SA/DA







.



rifles rifles







				
.308 Win. (7.62 x 51 NATO)	660	1 220 x 163 x 53	5 600	10

Příslušenství není součástí výrobku / Accessories are not part of the product. / Das Zubehör ist nicht Bestandteil des Produktes. / Les accessoires ne font pas partie du produit. / Los accesorios no forman parte del producto



CZ 527 Carbine

- (CZ)** Vhodná k výcviku střelby s použitím zavedeného vojenského střeliva.
- (GB)** Suitable for shooting practice using standard military ammunition.
- (D)** Geeignet zum Übungsschießen mit dem Einsatz der eingeführten Militärmunition.
- (F)** Carabines approprié pour l'entraînement de tir avec les munitions militaires courantes.
- (E)** Adecuado para el entrenamiento del tiro con el uso de la munición militar acreditada.

				
7.62 x 39 .223 Rem.	470	950 x 202 x 75	2 700	5



CZ 750 S1 M1

- (CZ) Odštělovačská puška určená k ničení živých cílů protivníka s vysokou účinností a k ničení lehkých materiálních cílů. Je také vhodná pro výcvik specialistů.
- (GB) Sniper rifle designed for enemy live targets annihilation with high efficiency and for light materiel targets destruction. This model is also suitable for specialised personnel training.
- (D) Scharfschützengewehr ist zum Vernichten lebendiger Ziele des Gegners mit hohem Wirkungsgrad und zum Vernichten leichter materiellen Ziele bestimmt. Sie ist auch zur Übung der Spezialisten geeignet.
- (F) Carabine de sniper à paralyser des cibles vives et matériels légères très efficace. Carabine est aussi appropriée pour la formation de tireurs d'élite.
- (E) Rifle para francotirador destinado para la destrucción de blancos vivos del enemigo con una gran eficiencia y también para la destrucción de blancos materiales ligeros. Es muy recomendado para el entrenamiento de fuerzas especiales.



CZ 452 – 2E ZKM Scout

- (CZ) Krátká malorážka pro přežití v krizových situacích.
- (GB) Short rimfire rifle for survival at demanding situations.
- (D) Kürze Kleinkaliberbüchse zum Überleben in der kritischen Situation.
- (F) Une carabine de petit calibre destiné à survivre aux situations critiques.
- (E) Carabina corta para la supervivencia en situaciones del peligro inminente.



.22 LR
.22 WMR



412



817 x 175 x 64



1 800



5 / 10
5

assault rifles



P-1107-0017



P-1107-0018



Sa vz. 58

- (CZ) Samopal vz. 58 je osobní zbraň příslušníků všech druhů vojsk. Je to automatická, lehká ruční zbraň ráže 7,62 x 39 mm, která umožňuje střelbu v dávkách i jednotlivými ranami.
- (GB) The Model 58 Assault Rifle is an individual weapon for all kinds of armed forces. It is an automatic, light small arm in cal. 7,62 x 39 mm, allowing the fire to be conducted either in bursts or semi-automatic mode.
- (D) Maschienengewehr Mod.58 ist die Personalwaffe der Angehörigen von allen Militärkräften. Das ist automatische und leichte Handwaffe, die das Feuer mit Serienschüssen und auch Einzelschüssen ermöglicht.
- (F) Le fusil mitrailleur 58 est une arme personnelle pour tous les membres des différentes forces armées. C'est une arme à main légère et automatique de calibre 7,62 x 39 mm qui permet un tir en salves ou au coup par coup.
- (E) La ametralladora Mod. 58 es un arma personal de miembros de todo tipo de fuerzas armadas. Es un arma de mano ligera, automática, cal. 7,62 x 39 mm, que facilita el el tiro en ráfagas o tiro a tiro.

P-1107-0017	ST	7.62x39	390	845 x 255 x 57	2 910	30		
P-1107-0018	ST	7.62x39	390	845/636 x 255 x 57	2 910	30		



P-1107-0101



P-1107-0100



CZ 858 TACTICAL

- (CZ) CZ 858 je samonabíjecí puška určená ke sportovní střelbě.
- (GB) The CZ 858 is a semi-automatic rifle designed for sport shooting.
- (D) CZ 858 ist die Selbstladbüchse, die für Sportschiessen bestimmt ist.
- (F) CZ 858 est une carabine auto-chargeante conçue pour le tir sportif.
- (E) CZ 858 - fusil semiautomático destinado para el tiro deportivo.

P-1107-0101	ST	7.62x39	390	845 x 255 x 57	2 910	30	•	•
P-1107-0100	ST	7.62x39	390	845/636 x 255 x 57	2 910	30	•	•

military accessories



- (CZ) Ochranná protiúderová přilba
- (GB) Protective riot helmet
- (D) Gegenschlag-Schutzhelm
- (F) Casque de protection anti-coups
- (E) Casco protector contra golpes



Tréninková přilba
Practice helmet
Übungshelm
Casque d'entraînement
Casco de entrenamiento



Tréninková přilba s převlekem
Practice helmet with textile cover
Übungshelm mit Verkleidung
Casque d'entraînement avec camouflage
Casco de entrenamiento con camuflaje



Balistická a protistřepinová přilba
Ballistic and anti-shrapnel helmet
Ballistischer und splittersicherer Helm
Casque pare-balle et anti-éclats
Casco antibala y contra esquirlas





5175-0007

Balistická tělová vesta pro skryté nošení
Ballistic body vest for concealed wearing
Ballistische Körperweste für verdecktes Tragen
Gilet pare-balle de corps pour port caché
Chaleco antibala para uso oculto



5715-0017

Protiúderové rukavice
riot gloves
Gegenschlag-Handschuhe
Gants anti-coups
Guantes contra golpes

1 Balistická vesta pro vrchní nošení
Ballistic vest for top wear
Ballistische Weste als Oberbekleidung
Gilet pare-balle pour port externe
Chaleco antibala para uso exterior

4 5175-0021
Ochranný protiúderový štít
Protective riot shield
Gegenschlag-Schutzschild
Écran de protection anti-coups
Escudo protector contra golpes



5110-0200

Taktický opasek
Tactical belt
Taktischer Gürtel
Ceinture tactique
Correa táctica

2 5175-0016
Protiúderové rukavice dlouhé
Long riot gloves
Lange Gegenschlag-Handschuhe
Longs gants riot
Guantes largos contra golpes

5 5175-0015
Ochranná protiúderová přilba
Protective riot helmet
Gegenschlag-Schutzhelm
Casque de protection anti-coups
Casco protector contra golpes

3 5125-0670
Taktické pouzdro s pryžovou vložkou a krycí chlopní pro pistoli CZ 75 D Compact
Tactical holster with rubber lining and cover flap designed for the CZ 75 D Compact pistol
Taktische Pistolenholster mit Gummieinsatz und Abdeckklappe für Pistole CZ 75 D Compact
Étui tactique avec douille en caoutchouc et valve de couverture pour pistolet CZ 75 D Compact
Funda táctica con una inserción de goma y una aleta para cubrir la pistola CZ 75 D Compact

6 8190-0022
Služební prošívaná obuv
Service shoes
Abgesteppte Dienstschuhe
Chaussure matelassée de service
Calzado de servicio respuntheado

military accessories

3194-0204

Taktická svítilna M3
Tactical light M3
Taktische Lampe M3
Lampe tactique M3
Lámpara táctica M3



3194-0205

Taktická svítilna s laserem M6
Tactical light with M6 laser
Taktische Lampe mit Laseraufsatz M6
Lampe tactique avec pointeur laser M6
Lámpara táctica con láser M6



5138-0500

Pouzdro na zásobník CZ 75 D COMPACT
CZ 75 D COMPACT magazine pouch
Magazin-Etui für CZ 75 D COMPACT
Étui de chargeur CZ 75 D COMPACT
Funda para cargador CZ 75 D COMPACT



5125-0602

Pouzdro pro pistolí CZ 75 D Compact s dvojným jištěním
Holster designed for the CZ 75 D Compact with double fastening
Pistolenholster für CZ 75 D Compact mit doppelter Sicherung
Étui pour pistolet CZ 75 D Compact avec double sécurité
Funda para la pistola CZ 75 D Compact con protección doble



Zásobník CZ 75 D COMPACT – 16, 25 nábojů
CZ 75 D COMPACT magazine – 16, 25 rounds
Magazin für CZ 75 D COMPACT – 16, 25 Patronen
Chargeur CZ 75 D COMPACT – 16, 25 cartouches
Cargador CZ 75 D COMPACT – 16, 25 cartuchos



0422-3710-1650

0422-3710-50



- 1 Služební pouzdro opaskové s pryžovou vložkou
 Duty belt holster with rubber inter-lining
 Dienstgürtelholster mit Gummieinsatz
 Étui de service, port à la ceinture, avec douille en caoutchouc
 Funda de servicio para cinturón con inserción de goma
CZ 75/85 5125-0654
CZ 75 D Compact 5125-0652
CZ 82/83 5125-0049

- 2 Opaskové pouzdro s pryžovou vložkou
 Belt holster with rubber lining
 Gürtelholster mit Gummieinsatz
 Étui pour port à la ceinture, avec douille en caoutchouc
 Funda para cinturón con inserción de goma
CZ 75/85 5125-0086
CZ 75 D Compact 5125-0100
CZ 82/83 5125-0110
CZ 100 5125-0111

- 3 Služební pouzdro opaskové – kůže
 Service belt holster – leather
 Dienstgürtel-Etui – Leder
 Étui de service pour port à la ceinture – cuir
 Funda de servicio para cinturón - cuero legítimo
CZ 75/85 5125-0046
CZ 75 Dcompact 5125-0134
CZ 82/83 5125-0082
CZ 100 5125-0135
CZ 75 Full Auto 5125-0084

- 4 Taktické pouzdro
 Tactical holster
 Taktische Pistolenhalter
 Étui tactique
 Funda táctica
Sa vz.61 Skorpion 5125-0702



- 5 Taktické pouzdro
 Tactical holster
 Taktische Pistolenhalter
 Étui tactique
 Funda táctica
CZ 75/85 5125-0108
CZ 75 D Compact 5125-0109
CZ 100 5125-0112

military accessories



- 1 5125-0032
 Vojenské nylonové pouzdro na CZ 75/85
 Military nylon holster for CZ 75/85
 Pistolentasche aus Nylon für CZ 75/85
 Douille militaire en nylon pour CZ 75/85
 Funda militar de nylon para CZ 75/85

- 2 5125-0704
 Vojenské pouzdro na samopal Skorpion
 Military holster for Skorpion sub-machine-gun
 Futteral für Maschinenpistole Skorpion
 Douille militaire pour mitraillette Skorpion
 Funda militar para la ametralladora Skorpion

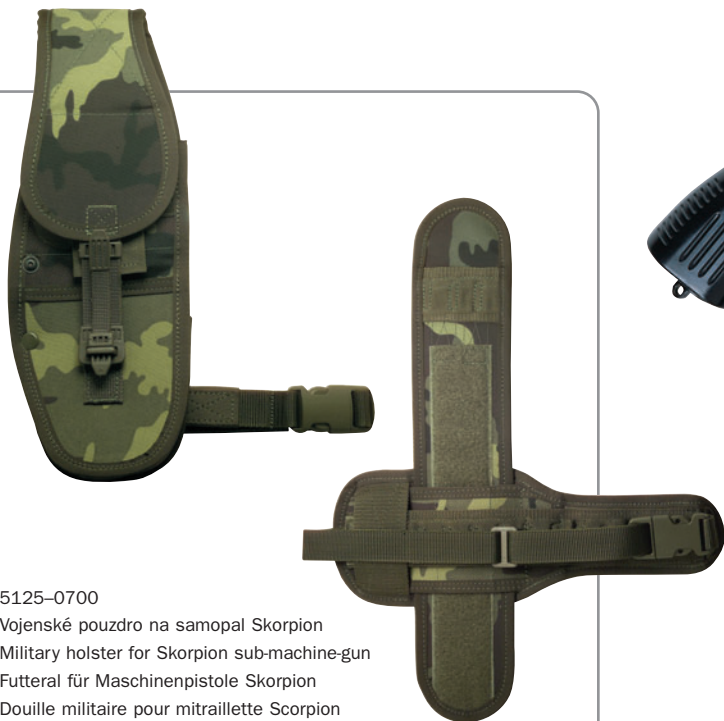

- 3 5125-0700
 Vojenské pouzdro na samopal Skorpion
 Military holster for Skorpion sub-machine-gun
 Futteral für Maschinenpistole Skorpion
 Douille militaire pour mitraillette Skorpion
 Funda militar para la ametralladora Skorpion

- 4 5110-0203
 Taktický závěs univerzální
 Tactical universal hanger
 Taktischer Universalaufhänger
 Bretelle tactique universelle
 Portafundas táctico universal



- 5 Vojenské pouzdro
 Military nylon holster
 Pistolentasche aus Nylon
 Douille militaire en nylon
 Funda militar de nylon
CZ 75/85 5125-0653
CZ 75 D Compact 5125-0113
CZ 83 5125-0114



8190-0020
COMBAT 2000



8190-0021
COMBAT 2000 – Desert



8190-0017
COMBAT model no. 1



8190-0022
COMBAT model no. 2



8190-0201 *
MIL-C-1DUL



8190-0205 *
COLD CLIMATE BOOTS



8190-0202 *
PILOT BOOTS



8190-0204 *
RANGER



8190-0203 *
MIL-TX2-1DUL



8190-0200 *
MIL-TX3-1DUL

* Pro velké odběrové množství / For large quantity purchase / Für große Abnahmemengen / Pour achat de grande quantité / Para la cantidad grande de la toma

